



enjoy.now

alcatel A31^{PRIME}

Note:

This is a user manual for Alcatel A31 Prime T451A1.

There may be certain differences between the user manual description and the phone's operation, depending on the software release of your phone or specific operator services.

Help

Refer to the following resources to get more FAQ, software, and service information:

Consulting FAQ

Go to <https://www.alcatelmobile.com/support/>

Finding your serial number or IMEI

You can find your serial number or International Mobile Equipment Identity (IMEI) on the packaging materials. Alternatively, choose **Settings > About phone > IMEI** on the phone itself.

Obtaining warranty service

First follow the advice in this guide or go to <https://www.alcatelmobile.com/contact-us/>. Then check hotlines and repair centre information.

Viewing legal information

On the phone, go to **Settings > About phone > Legal information**.

Table of Contents

1	Basics.....	4
1.1	Device overview.....	4
1.2	Getting started	7
1.3	Home screen.....	9
1.4	Text input.....	17
2	Multimedia applications	19
2.1	Camera	19
3	Apps and features	23
3.1	Phone.....	23
3.2	Contacts.....	29
3.3	Messages	32
3.4	Calendar.....	34
3.5	Clock.....	35
3.6	Support Center.....	36
3.7	Other applications	36
3.8	Google applications.....	36
4	Settings	38
4.1	Network & internet.....	38
4.2	Connected devices	41
4.3	Apps.....	42
4.4	Notifications.....	42
4.5	Battery.....	43
4.6	Storage	43
4.7	Scheduled power on/off	43

4.8	Sound & vibration.....	43
4.9	Display.....	44
4.10	Wallpaper & Style.....	44
4.11	Accessibility.....	44
4.12	Security & privacy.....	44
4.13	Location.....	45
4.14	Safety & emergency.....	46
4.15	Passwords & accounts.....	46
4.16	Passwords, passkeys & accounts.....	46
4.17	Digital Wellbeing and parental controls.....	46
4.18	Google.....	46
4.19	System.....	47
4.20	About phone.....	48
5	Troubleshooting.....	49
6	Specifications.....	56
7	Accessories.....	58
8	Licences.....	58
9	Disclaimer.....	58

1 Basics

1.1 Device overview

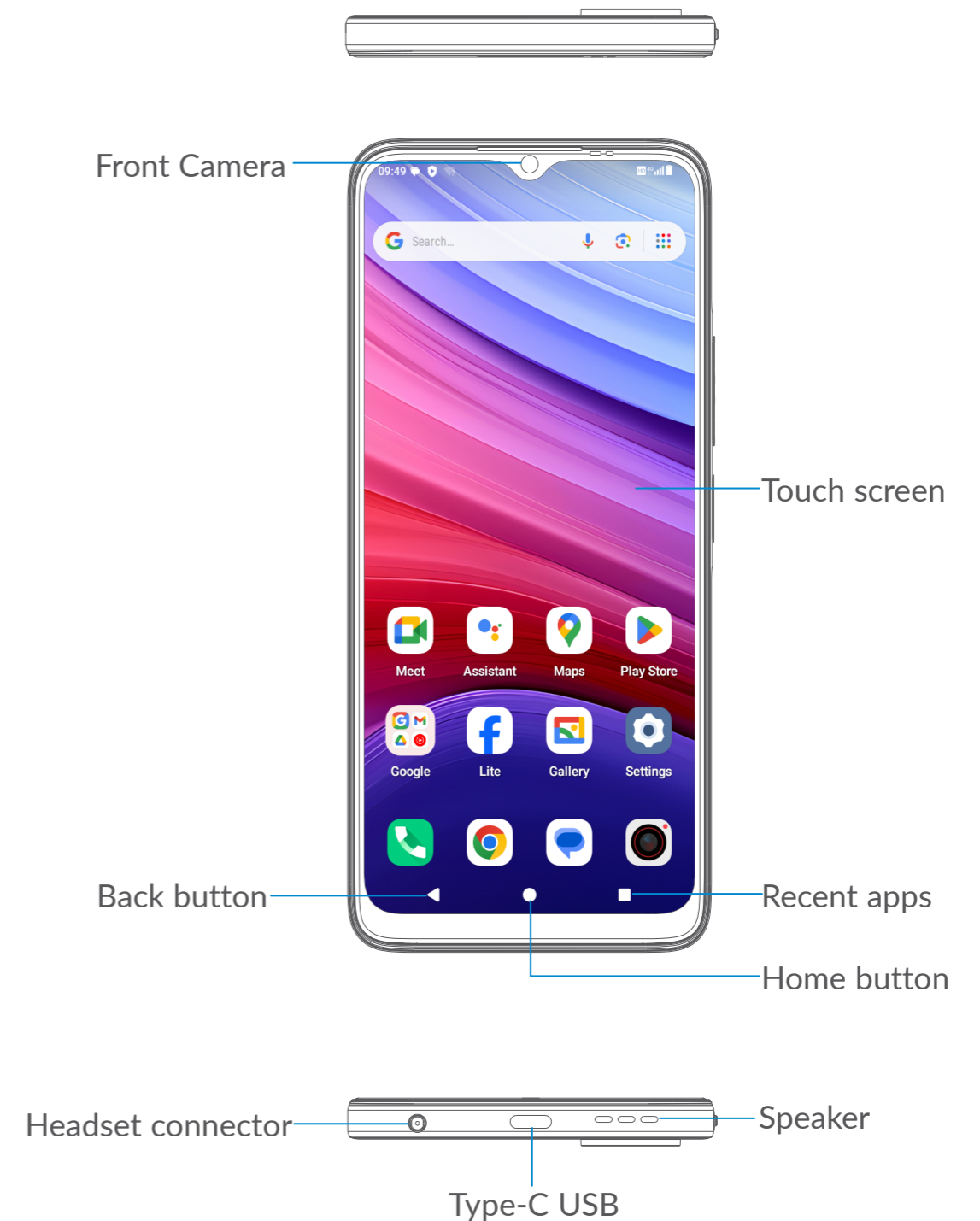

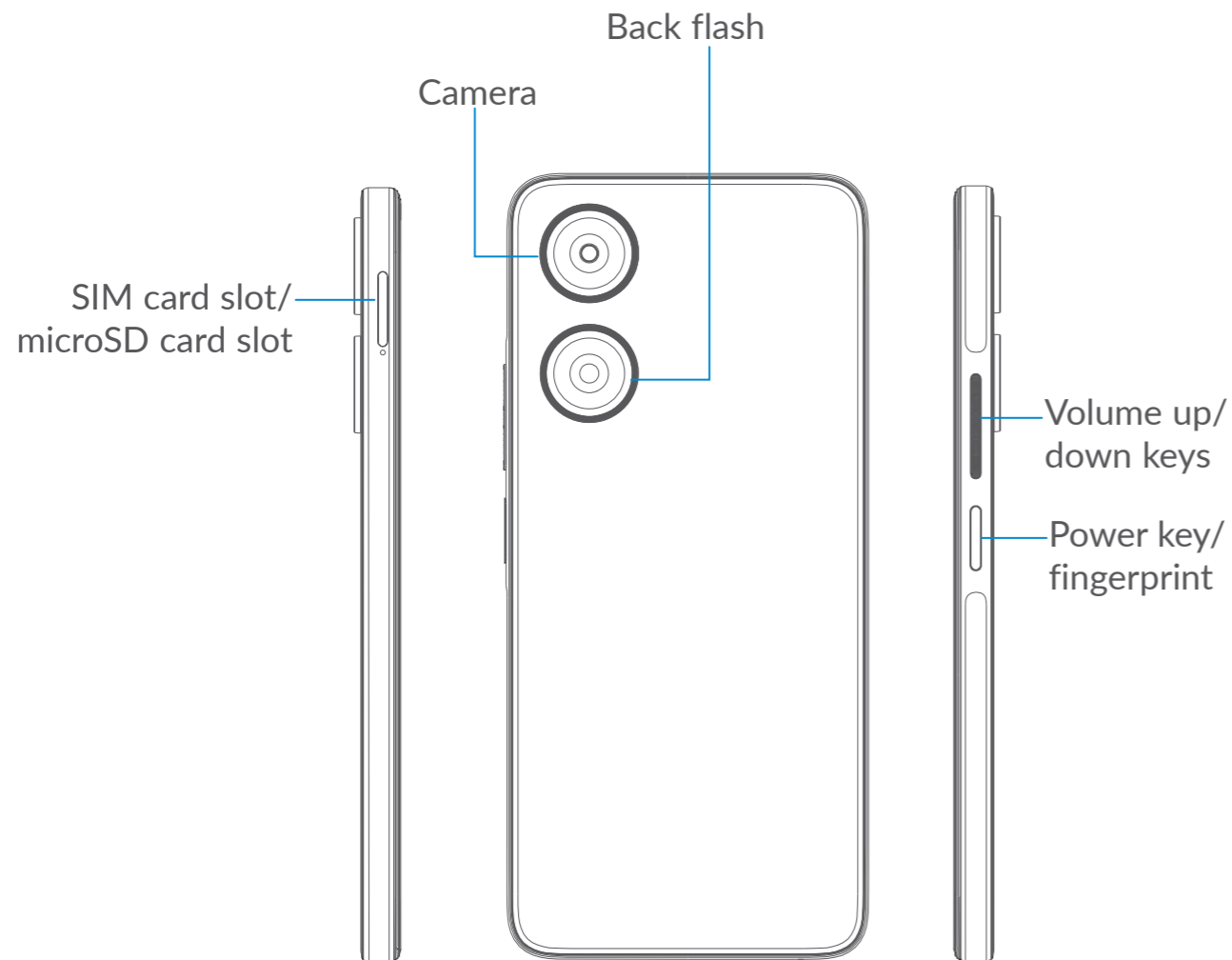

Back button

- Touch to go back to the previous screen, or to close a dialog box, options menu, the notification panel, etc.

Home button

- From any application or screen, touch to return to the Home screen.
- Touch and hold to turn on Google Assistant. You can get help such as getting directions and restaurant information based on the content detected on the screen.

Recent apps

- Touch to view applications you've recently accessed

Power key

- Press: Lock the screen/Light up the screen.
- Press and hold: Add Account
- Press the **Power** key and **Volume up** key at the same time to show the popup menu to select from Emergency/Power off/Restart.
- Press the **Power** key and **Volume down** key at the same time to take a screenshot.
- Press and hold the **Power** key for at least 8 seconds to force reboot.
- Double-press the Power key to open the camera.

Volume Keys

- In call mode, adjusts the earpiece or headset volume.
- In Music/Video/Streaming mode, adjusts the media volume.
- In general mode, adjusts the media volume.
- Mutes the ringtone of an incoming call.
- In camera preview mode, press the **Volume up** or **down** key to take a photo or press and hold to take burst shots.

1.2 Getting started

Setting up

Inserting or removing the SIM/microSD card

- 1 Insert the provided SIM pin into the hole.
- 2 Pull out the SIM tray.
- 3 Place the SIM card or microSD card into the tray slot and carefully close the SIM tray.

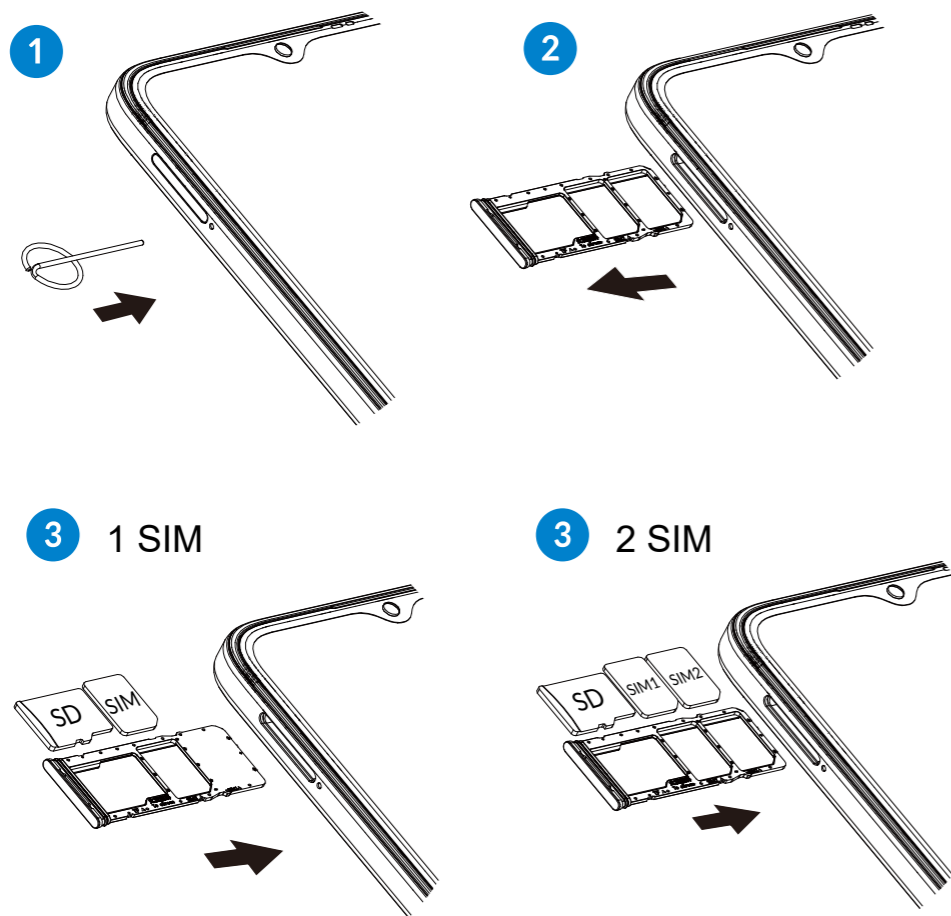



You must insert your SIM card to make phone calls. You do not need to power off your phone before inserting or removing the SIM card as this phone supports hot swap.

 Your phone only supports nano-SIM cards. Do not attempt to insert other SIM types; otherwise this may cause damage to your phone.

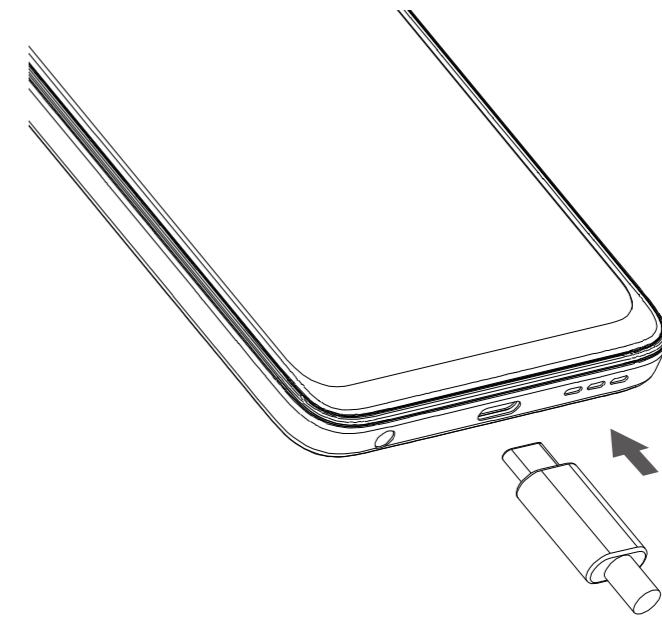
Charging the battery



You are advised to fully charge the battery (). Charging status is indicated by a percentage displayed on screen while the phone is powered off. The percentage increases as the phone is charged.

 To reduce power consumption and energy waste when the battery is fully charged, disconnect your charger from the plug; switch off Wi-Fi, GPS, Bluetooth or background-running applications when not in use; reduce the backlight time, etc.

Powering on your phone

Hold down the **Power** key until the phone powers on, unlock your phone (Swipe, PIN, Password, Pattern, Fingerprint or Face recognition) if necessary and confirm. The Home screen is displayed.

If you do not know your PIN code or forget it, contact your network operator. Be sure to keep your PIN code secure.

Powering off your phone

Press the **Power** key and **Volume up** key at the same time to show the popup menu, then select **Power off**.

1.3 Home screen

You can bring all the items (applications, shortcuts and folders) you love or use most frequently to your Home screen for quick access. Touch the **Home** button to switch to the Home screen.

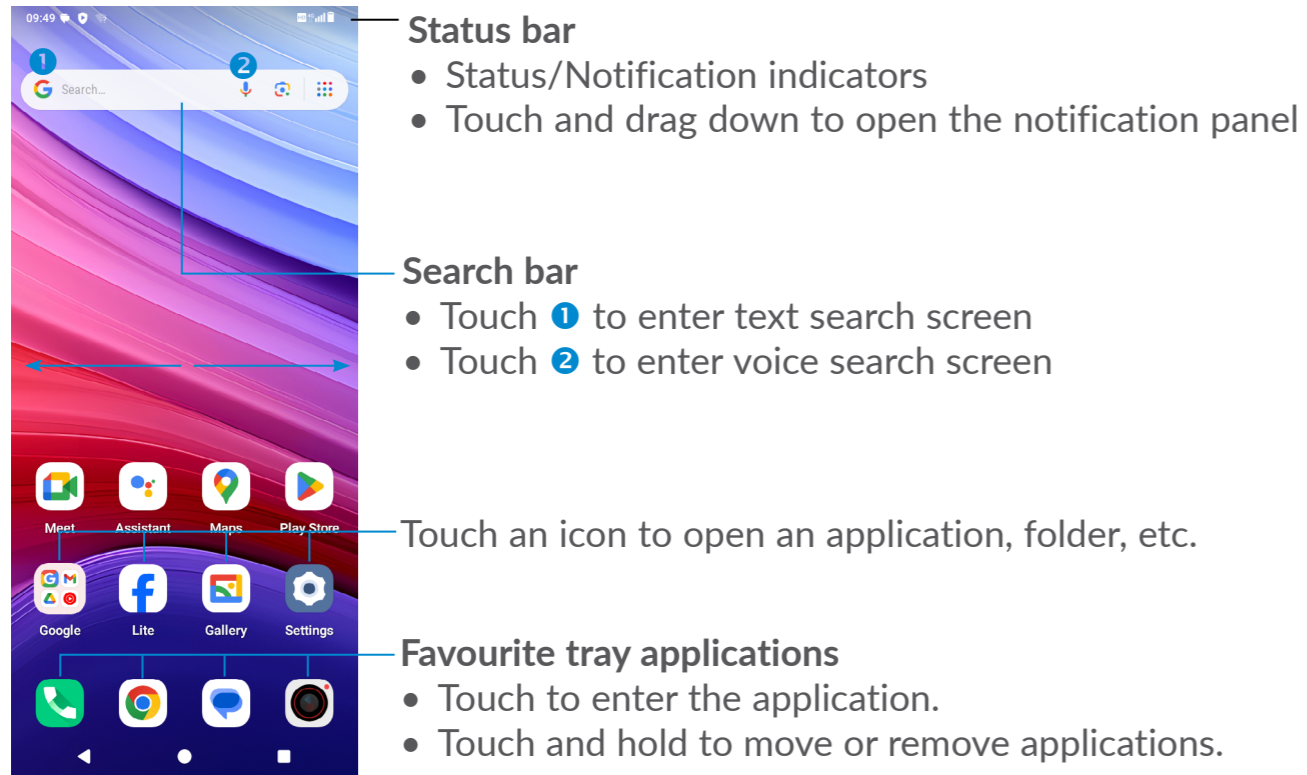

The Home screen is provided in an extended format to allow more space for adding applications, shortcuts etc. Slide the Home screen horizontally left and right to get a complete view.

Using the touchscreen

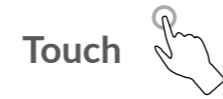

To access an application, touch it with your finger.

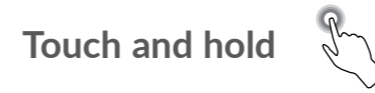

To enter the available options for an item, touch and hold the item. For example. Select a contact in Contacts and touch and hold it. An options list will then appear.



Place your finger on the screen to drag an object to another location.



Slide the screen to scroll up and down the applications, images, and web pages. You can slide the screen horizontally too.



Similar to swiping, but flicking makes it move quicker.



Place two fingers on the screen surface and draw them apart or together to scale an element on the screen.



Automatically change the screen orientation from portrait to landscape by turning the phone sideways to have a better screen view.

Status bar

From the status bar, you can view both phone status and notification information.

Drag down the status bar to view notifications and drag again to enter the quick settings panel.

Touch and drag up to close it. When there are notifications, they can be accessed by touching them.

Notification panel

When there are notifications, touch and drag down the Status bar to open the Notification panel to read more detailed information.

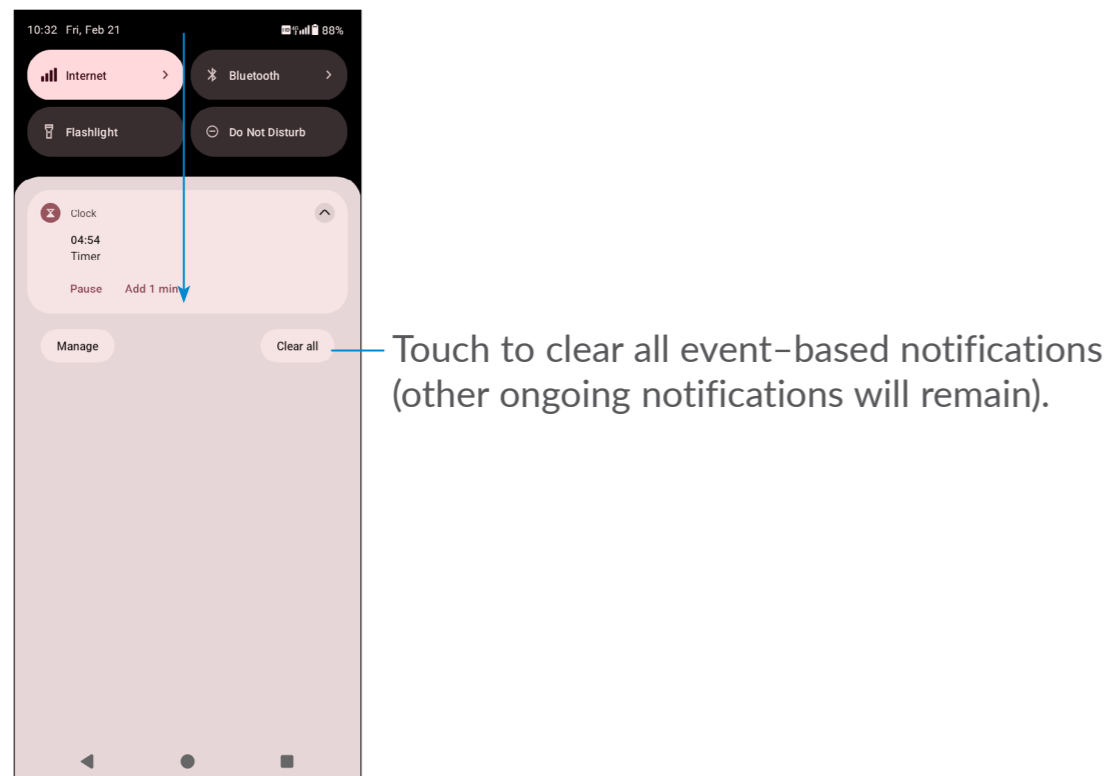

Quick settings panel

Touch and drag down from the top of the screen twice to open the Quick settings panel.

You can enable or disable functions or change modes by touching the icons.

Touch the **Edit** icon  to customise your Quick settings panel.

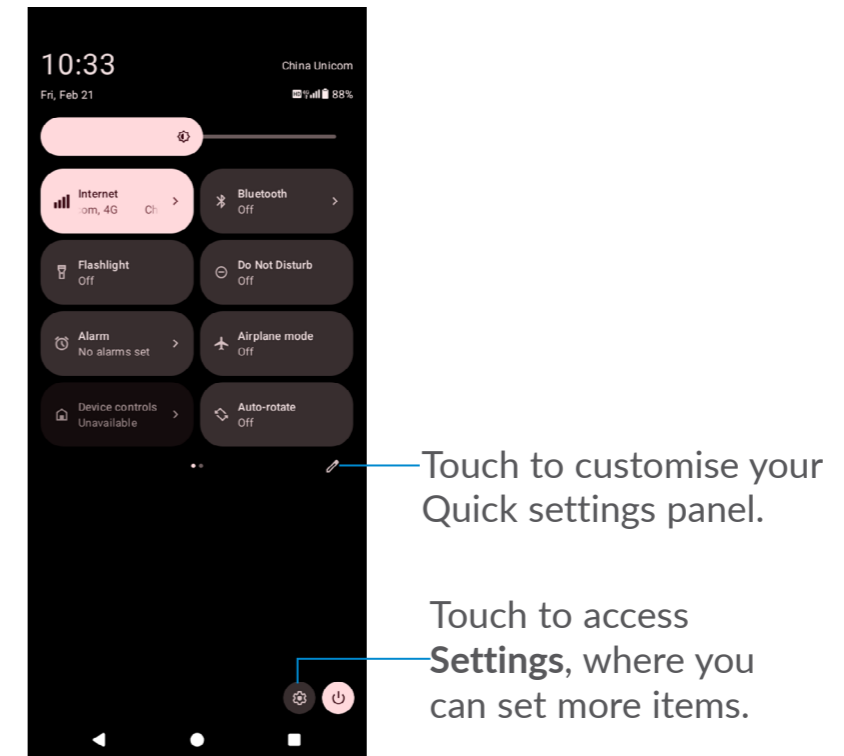

Lock/Unlock your screen

To protect your phone and privacy, you can lock the screen with a pattern, PIN, password, fingerprint or face.

To create a screen unlock pattern, touch **Settings > Security & privacy > Device unlock**.

To lock the phone screen

- If your phone remains inactive for a period of time, it will automatically lock the screen and enter sleep mode to save power. Go to **Settings > Display > Screen timeout** and select a screen timeout period.
- You can also manually lock the screen by pressing the **Power** key once.

To unlock the phone screen

Press the **Power** key once to light up the screen, swipe up and unlock the screen with the method you have set.

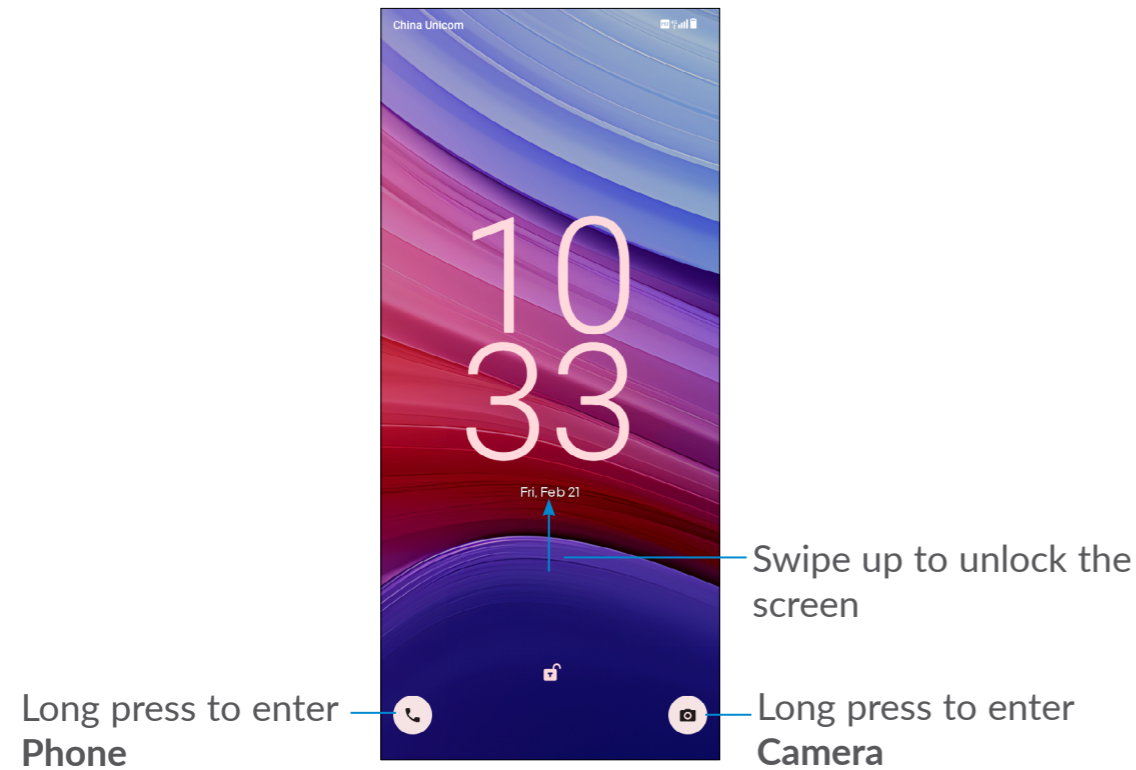

Enter a password to unlock the screen

Once the screen is turned on, swipe up from any position on the screen to display the password input panel. Then enter your lock screen password.

Use pattern unlock

Draw the same pattern you have set to unlock the screen.

Use Face unlock

- From the app list, touch **Settings > Security & privacy > Device unlock > Face & Fingerprint Unlock > Face unlock**. Before using the face key, you need to set a pattern/PIN/password.
- Hold your phone 20-50 cm from your face. Position your face in the square shown on the screen. For best results, we suggest that the face key is enrolled indoors and away from direct sunlight.
- Enable Face unlock when your screen turns on, otherwise you will have to swipe up on the screen first of all.

Use fingerprint unlock

- Touch the fingerprint sensor (**Settings > Security & privacy > Device unlock > Face & fingerprint unlock > Fingerprint**) with an enrolled finger to unlock the screen.

Personalising your Home screen

Add

You can touch and hold a folder or an application and drag the item to your preferred Home screen.

Reposition

Touch and hold an item and drag it to the desired position and then release. You can move items both on the Home screen and the Favourite tray. Hold the icon on the left or right edge of the screen to drag the item to another Home screen.

Remove

Touch and hold the item and drag it up to the top of the **x Remove** icon, and release after it changes colour.

Create folders

To improve the organisation of shortcuts or applications on the Home screen and the Favourite tray, you can add them to a folder by stacking one item on top of another. To rename a folder, open it and touch the folder's title bar to input the new name.

Wallpaper customisation

Touch and hold an empty area on the Home screen, then touch **Wallpaper & style** to customise wallpaper.

Recently used applications

Consult recently used applications

To consult recently used applications, touch the **Recent apps** key. Touch a thumbnail in the window to open the application.

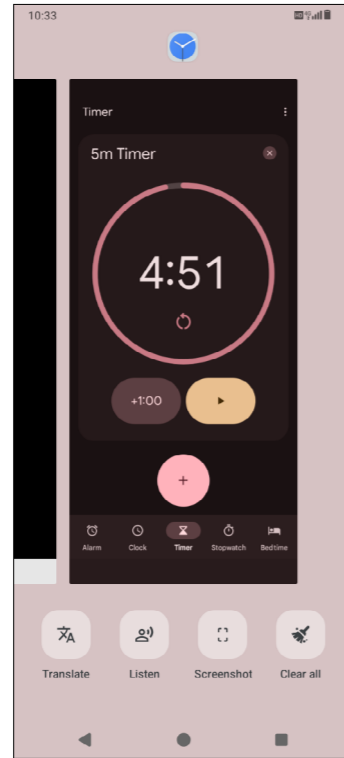

Touch one thumbnail and slide it up to close the application, slide it right/left to switch between the applications.

Volume adjustment

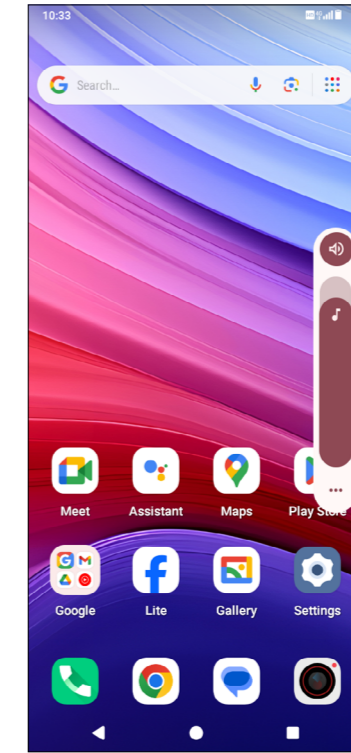

Press the **Volume** key to adjust the volume.

Touch the **•••** icon to adjust Media, Call, Ring, Notification and Alarm.

1.4 Text input

Using the Onscreen Keyboard

Onscreen Keyboard settings

Touch **Settings > System > Keyboard**, touch the keyboard you want to set up and a series of settings will become available.

Adjust the Onscreen Keyboard orientation

Turn the phone sideways or upright to adjust the onscreen keyboard orientation. You can adjust it by changing the settings (Touch **Settings > Display > Auto-rotate screen**).

- **Gboard**

Touch to show more options.

Touch to switch between "abc/Abc" mode;
Touch and hold to switch to "abc/ABC" mode.

Switch between alphabetical and numeric keyboard.

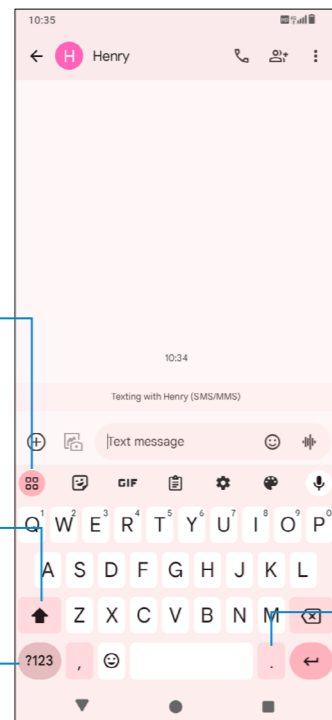

Touch and hold to select symbols.

Text editing

You can edit text which you have entered.

- Touch and hold or double touch within the text you want to edit.
- Drag the tabs to change the amount of text to edit.

You can also insert new texts if preferred

- Touch where you want to type, or touch and hold a blank area. The cursor will blink and the tab will appear. Drag the tab to move the cursor.
- If you have cut or copied any text, touch the tab to show the Paste and Select all option which allows you to complete pasting immediately.

2 Multimedia applications

2.1 Camera



Before using the camera, make sure that you remove the protective lens cover to avoid it affecting your picture quality.

Launch Camera

There are multiple ways to open the Camera app.

From the Home Screen

From the home screen, touch **Camera** .

From the Lock Screen

When the screen is locked, press the Power key once to light up the screen, then long press the camera icon in the lower right corner to open the camera.

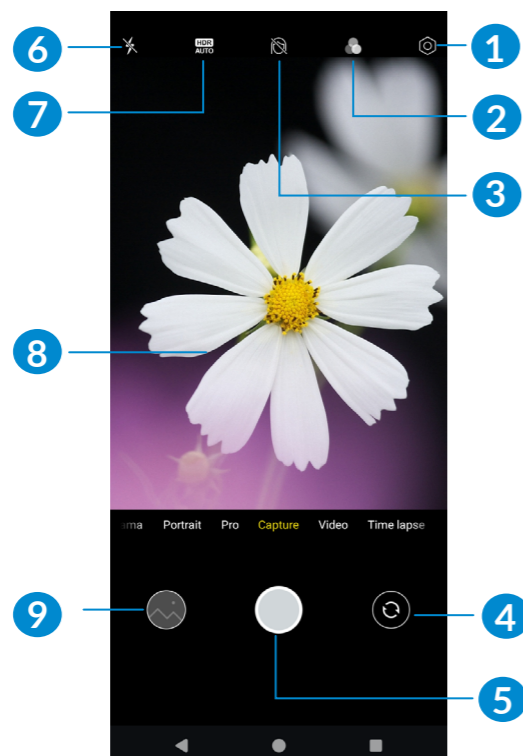

Using a shortcut key

Simply double-press the **Power** key to open the camera.







- 1 Touch to access settings
- 2 Select filter
- 3 Face Beauty: Touch to adjust skin smoothing and enhance coloring effects in portraits.
- 4 Switch between front/back camera
- 5 Take a photo
- 6 Flash mode
Touch to turn on/off the camera flash.
WARNING: Keep a safe distance when using the flash. Do not point the flash toward people's or animals' eyes.
- 7 Take HDR photos
- 8 Pinch fingers together to zoom out, or spread fingers apart to zoom in
- 9 View the photos or videos you have taken

To take a photo



The screen acts as the viewfinder. First, position the object or landscape in the viewfinder, touch the screen to focus if necessary. Touch  to capture. The photo will be automatically saved. You can also touch and hold  to take burst shots.

To take a video

Touch **VIDEO** to change the camera mode to video. Touch  to start video recording. Touch the left part of this icon  to take a picture during video recording.

Touch the right part of this icon  to pause video recording and touch  to continue. Touch  to stop recording. The video will be automatically saved.

Further operations when viewing a photo/video you have taken

- Slide left or right to view the photos or videos you have taken.
- Touch , you can select **Bluetooth**, **Messages**, **Gmail**, etc. to share the photo or video.
- Touch **Back button**  to return to **Camera**.

Modes and settings

Modes

Slide left or right to switch between modes.

- **Panorama:** Touch to turn on the panorama function. Touch the shutter button to start taking a panoramic photo and move the phone steadily along in the direction indicated by the onscreen line. Once the slots are filled, the photo will be automatically saved. If the slots are not fully filled, touch the shutter button again to save the photo.
- **PORTRAIT:** Touch to create a depth of field effect. You can compose an image that highlights your subject while producing a gorgeously blurred background.
- **PRO:** Pro camera mode lets you fine-tune parameters and gives you full control over ISO, WB exposure time, aperture, shutter speed and so on.
- **Capture:** Touch to take a photo.
- **VIDEO:** Touch to access video mode.
- **TIME LAPSE:** While time-lapses are viewed as videos, they are actually a sequence of raw images.

Shoot for 10 minutes and you will get a video with the preset scenario applied.
- **MORE:** Access more modes, such as Audio note, QR code.

Settings

Touch  to access the Settings screen.

- **Storage path:** Choose between phone and microSD™ card storage when a microSD™ card is inserted. The default is phone storage.
- **Volume key function:** Customize the Volume button to Shutter, Zoom or Volume when using camera.
- **Quick capture:** Set the device to take a photo by pressing the volume down key twice quickly when screen is off.
- **Camera sound:** Turn on/off. Shutter sound when taking a photo or video.
- **Save location:** Turn on/off. Tag photos and videos with your location. This option is available when GPS location services and wireless network are enabled, and permission is granted.
- **Picture size:** Set the photo MP size.

- **Picture quality:** Select picture quality.
- **Picture Watermark:** Turn on/off Watermark.
- **Countdown duration:** Select Countdown duration.
- **Composition line:** Select Composition line.
- **Level:** Touch to turn on/off level.
- **Smile Shutter:** Touch to turn on/off Smile Shutter.
- **AI scene recognition:** Touch the switch to activate/deactivate the function. With plenty of different scene detection, the camera will intelligently analyse the scene to optimize the parameters for a perfect shot.

3 Apps and features

3.1 Phone.....



Making a call

From the Home screen, touch

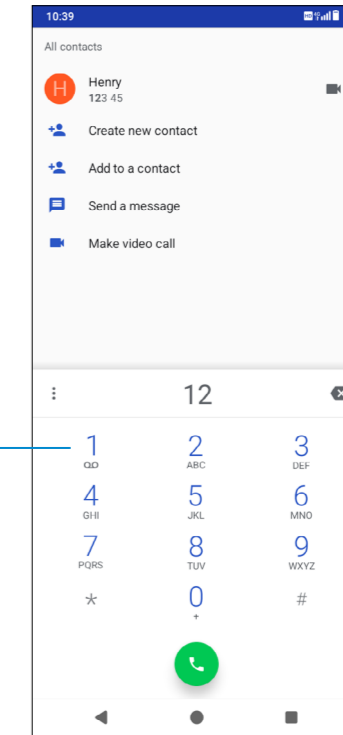
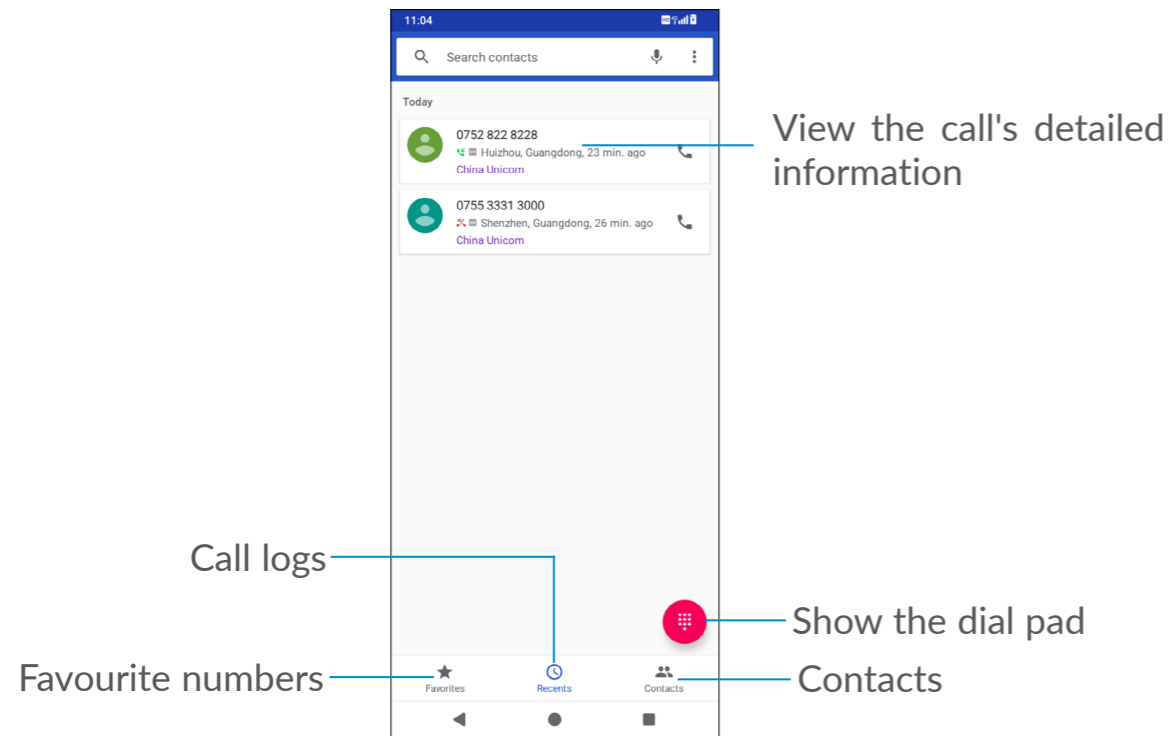

Enter the desired number from the dial pad and touch to place the call or select a contact from **Contacts** or **Call logs** by touching tabs, then make the call.

The number you entered can be saved to **Contacts** by touching **Create new contact** or **Add to a contact**.

If you make a mistake, you can delete the incorrect digits by touching

To hang up a call, touch

International call

To dial an international call, touch and hold to enter "+", then enter the international country prefix followed by the full phone number and touch .



Emergency call

If your phone has network coverage, dial the emergency number and touch to make an emergency call. Depending on your network and country this could even work without a SIM card and without typing in the SIM PIN code.

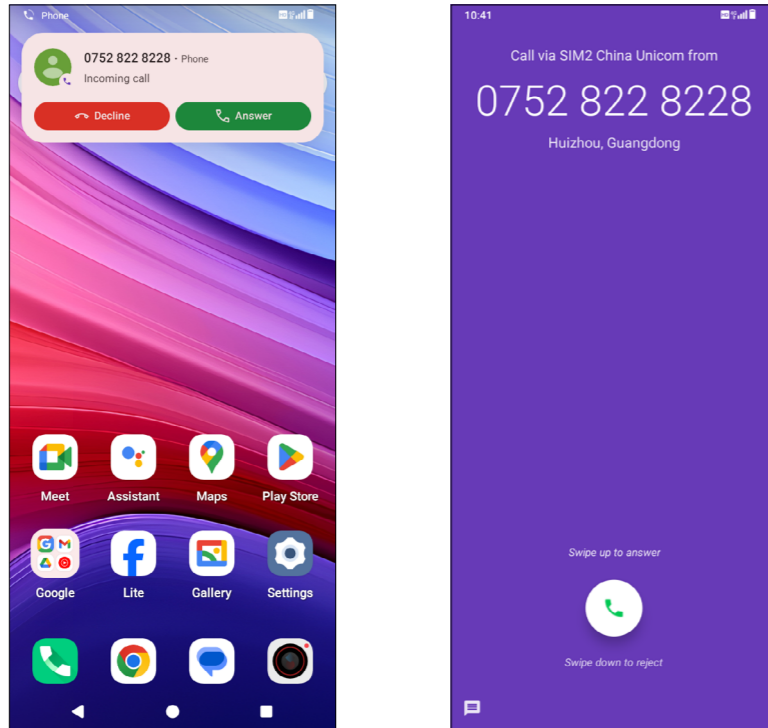
Answering or rejecting a call



When you receive a call:

- Swipe up the icon  to answer;
- Swipe down the icon  to reject;
- Touch  to reject the call by sending a preset message.

Calling your voicemail

Your voicemail is provided by your network to avoid missing calls. It works like an answering machine that you can consult at any time.

To access your voicemail, touch and hold .

If you receive a voicemail,  appears on the Status bar. Open the Notification panel and touch **New voicemail**.

During a call

To adjust the volume during a call, press the **Volume up/down** key.

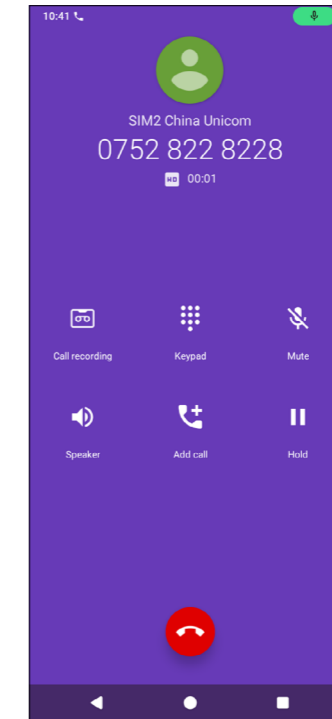

End the current call.



Display the dial pad.



Touch to mute the current call. Touch this icon again to unmute the call.



Touch to activate the speaker during the current call. Touch this icon again to deactivate the speaker.



Make another call



Put a call on hold



To avoid accidental operation of the touchscreen during a call, the screen will be locked automatically when you put the cellphone close to your ear; and it will be unlocked when the cellphone is taken away from your ear.

Managing multiple calls

With this phone you can handle multiple calls at the same time.

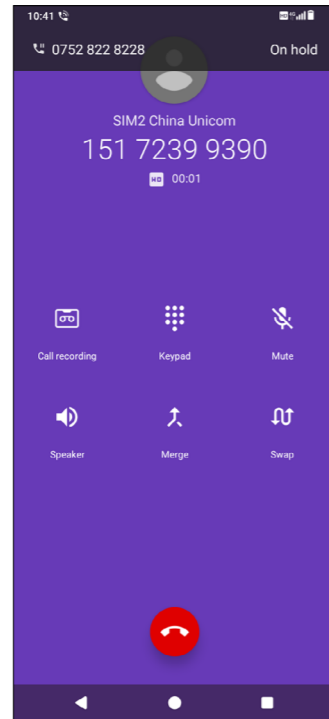





Swap calls

When you accept two calls, touch  icon to switch between two lines. The current call will be put on hold and you are able to join the other call.

Conference calls⁽¹⁾

You can set up a conference call as follows.

- Place a call to the first participant of the conference call.
- Touch  to add another call.
- Enter the phone number of the person you want to add to the conference and touch . You can also add participants from **Recent** or **Contacts**.
- Touch  to start the conference.
- Touch  to end the conference call and disconnect all callers.

⁽¹⁾ Depending on your network operator.

Call settings

Touch  from the **Phone** screen, then touch **Settings** to set phone and contact settings.

Call log

You can access your call logs by touching  from the **Phone** screen to view missed calls, outgoing calls and incoming calls.

Touch one call to view information or further operations. You can launch a new call, send a message to the contact or number, or view detailed information of the call.

To delete the call history of a selected contact or number, touch and hold the contact and choose **Delete**.

3.2 Contacts.....

Contacts enables quick and easy access to the contact you want to reach.

You can view and create contacts on your phone and synchronize these with your Gmail contacts or other applications on the web or on your phone.

Consult your Contacts

To see your contacts, swipe up from the Home screen and touch .

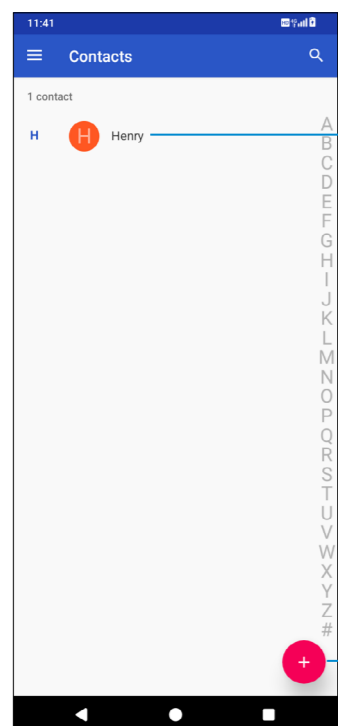

- Touch to open the Quick contact panel
- Touch and hold to share or delete the selected contact

 Add new contacts



Deleted contacts will also be removed from other applications on the phone or web the next time you synchronize your phone.

Adding a contact

Touch  in the contact list to create a new contact.

You are required to enter the contact's name and other contact information. By scrolling up and down the screen, you can move from one field to another.

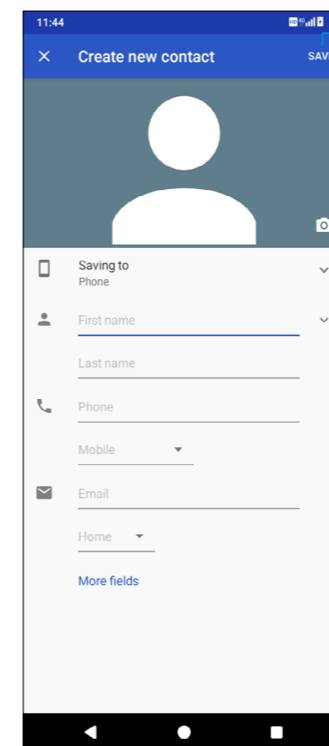



 Touch to save

 Select a picture or take a photo for the Phone contact

 Touch to show more options

Add to/remove from Favourites ⁽¹⁾

To add a contact to favourites, you can touch a contact to view details then touch  to add the contact to favourites.

To remove a contact from favourites, touch  on the contact details screen.

Editing your contacts

To edit contact information, touch  in the contact details screen.

When finished, touch **Save**.

⁽¹⁾ Phone and Gmail contacts can be added to favourites.

Using the Quick contact panel

Touch a contact to open the Quick contact panel.

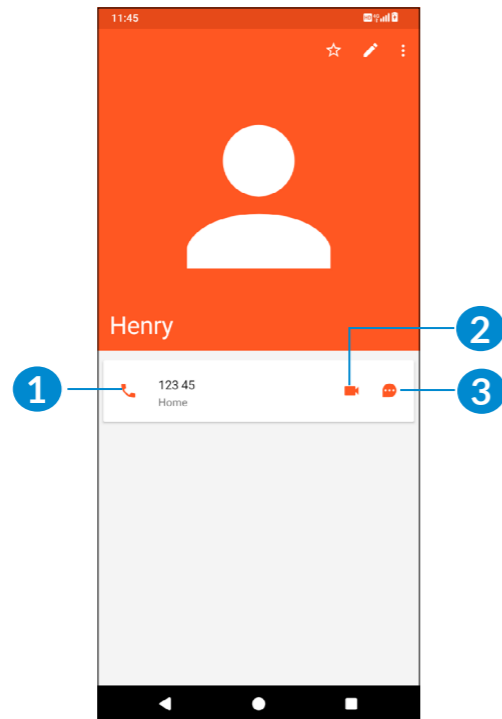

- 1 Touch to make a call
- 2 Touch to make a video call
- 3 Touch to send a message

The icons available on the Quick contact panel depend on the information you have for the contact and the applications and accounts on your phone.

Sharing contacts

You can share a single contact or contacts with others by sending the contact's vCard to them via Bluetooth, Gmail, etc.

- From the Contacts screen, touch and hold a contact and touch .
- Select the application to perform this action.

3.3 Messages



Writing a new message

You can create, edit, send and receive SMS and MMS with this phone.

To access Messages, touch  from the App drawer.

On the message list screen, touch **Start chat** to write text/multimedia messages.

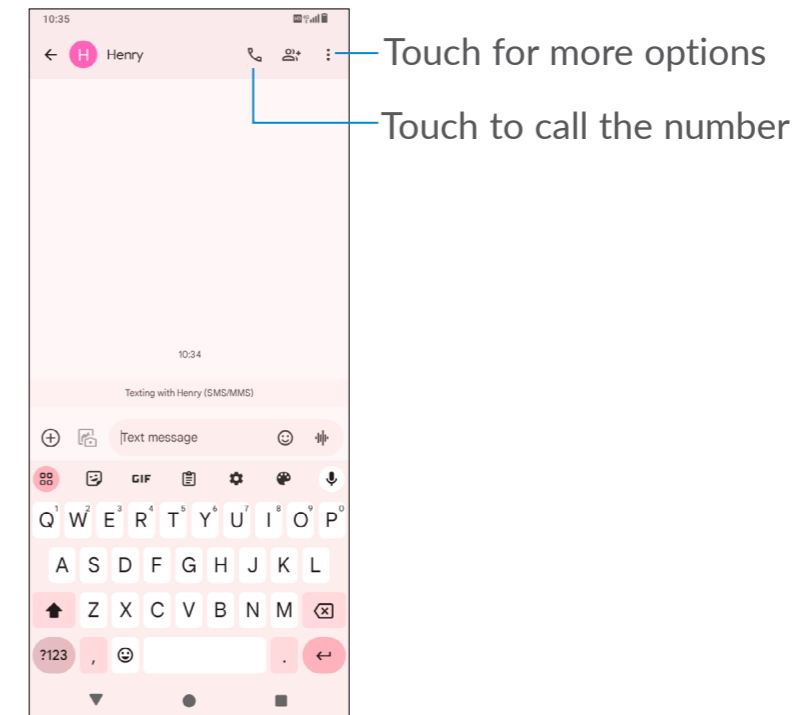

Sending a text message



- To add recipients, enter a mobile phone number or select a contact in the **To** bar.
- Touch the **Text message** bar to enter the text of the message.
- When finished, touch  to send the text message.

 Specific letters (accented) will also increase the size of the SMS. This may cause multiple SMS to be sent to your recipient.

Sending a multimedia message

MMS enables you to send video clips, images, photos, animations, slides and sounds to other compatible mobiles and e-mail addresses.

An SMS will be converted to MMS automatically when media files (image, video, audio, slides, etc.) are attached or subject or email addresses are added.

- To send a multimedia message, enter the recipient's phone number in the **To** bar.
- Write the text of the message in the **Text message** bar.
- Touch  to access to your location, send a voice message or attach files.
- Touch  to take a photo/video or attach a photo/video you have taken.
- When finished, touch  to send the multimedia message.

Manage messages

When receiving a message,  will appear on the Status bar as a notification. Drag down the Status bar to open the Notification panel. Touch the new message to open and read it. You can also access the **Messages** application and touch the message to open it.

Messages are displayed as a conversation.

Touch a message to enter the message composing screen:

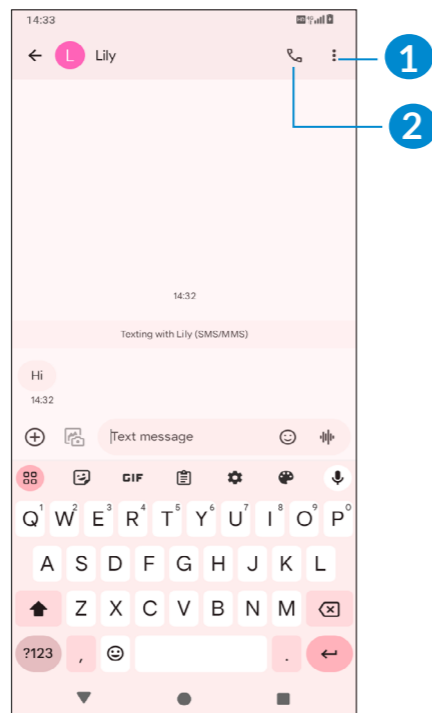

1 Touch for more options

2 Touch to call the number

To adjust message settings, touch  in the upper right and then select **Settings**

3.4 Calendar.....

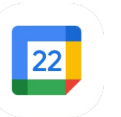

Use **Calendar** to keep track of important meetings, appointments, etc.

To view the calendar and create events, open the Google apps folder from the Home screen, then touch **Calendar**.

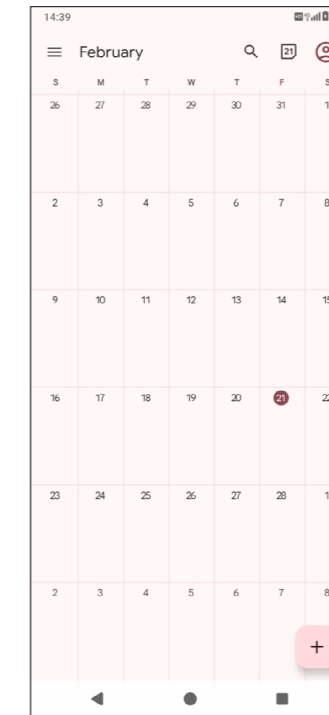



Multimode view

You can display the Calendar by **Schedule, Day, 3 days, Week, or Month**, touch  to select.



To create new events

You can add new events from any Calendar view.

- Touch .
- Fill in all required information for this new event. If it is a whole-day event, you can turn on **All-day** .
- Invite guests to the event. Enter the email addresses of the guests you want to invite with commas to separate. The guests will receive an invitation from Calendar and Email.
- When finished, touch **Save** at the top of the screen.

To quickly create an event from the Week view screens, touch an empty spot to select a target area which will then turn into , then touch the icon to create the new event.

To delete or edit an event

To delete or edit an event, touch the event to enter its details screen. Touch  to edit the event, or touch  and then **Delete** to delete.

3.5 Clock.....

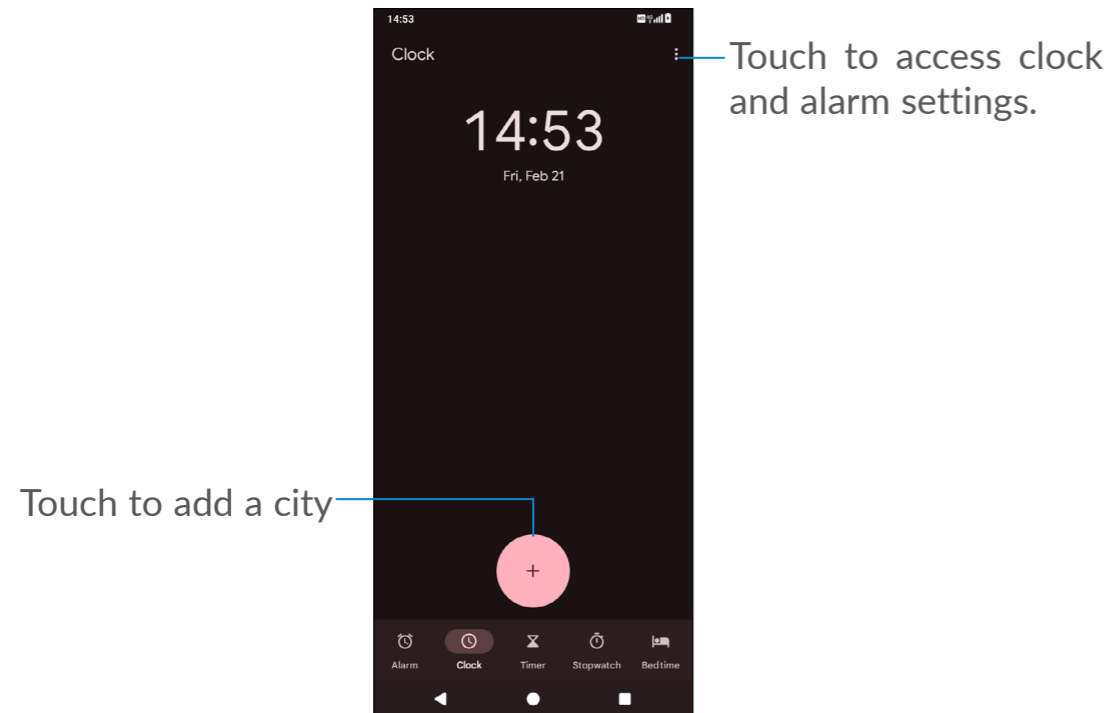

Your mobile phone has a built-in clock.

To view the current time, swipe up the Home screen, then touch **Clock**.



Alarm

From the Clock screen, touch **Alarm** to enter.

- Turn on  to enable the alarm.
- Touch  to add a new alarm, touch **Ok** to save.
- Touch a currently existing alarm to enter the alarm editing screen.
- Touch **Delete** to delete the selected alarm.

3.6 Support Center.....

Support Center helps you to learn more about Hot FAQs, operation instructions, troubleshooting, etc. Use it to send us your feedback.

3.7 Other applications ⁽¹⁾

The previous applications in this section are preinstalled on your phone. To download and install more 3rd party applications, use the Google Play Store application.

3.8 Google applications ⁽¹⁾

Google apps are preinstalled on your phone to improve work efficiency and help you enjoy life.

This manual briefly introduces the apps. For detailed features and user guides, refer to the related websites or the introduction provided in the apps.

You are recommended to register with a Google account to enjoy all the functions.

Gmail

As Google's web-based email service, Gmail is configured when you first set up your phone. With this application you can send and receive emails, manage emails by labels, archive emails, etc. Emails can be automatically synchronized with your Gmail account.

Maps

Google Maps offers satellite imagery, street maps, 360° panoramic views of streets, real-time traffic conditions, and route planning for travelling by foot, car, or public transportation. By using this application, you can find your own location, search for a place, and get suggested route planning for your trips.

Gallery

Gallery stores and backs up your photos and videos. It also automatically analyses photos and organizes them into groups, so that you can quickly find the photos you need.

⁽¹⁾ Application availability depends on country and operator.

Meet

Stay connected and collaborate effortlessly with the Meet menu on your smartphone. Join or schedule video meetings and group calls with ease.

YouTube

YouTube is an online video-sharing application where users can upload, view, and share videos. Available content includes video clips, TV clips, music videos, and other content such as video blogging, short original videos, and educational videos. It supports a streaming function that allows you to start watching videos almost as soon as they begin downloading from the internet.

Play Store

Serves as the official app store for the Android operating system, allowing users to browse and download applications and games. Applications are either free of charge or at a cost.

In Play Store, search for the app you need, download it and then follow the installation guide to install the app. You can also uninstall, update an app, and manage your downloads.

Google

A web browser with which you can surf the internet.

Your bookmarks, browsing history, and settings across all devices on which the browser is installed can be synchronized with your Google account.

Assistant

Long-pressing on the home button to launch the Assistant .

Files

Files displays all data stored on the phone, including both external SD card and internal storage, such as applications, media files downloaded from Google Play Store, YouTube or other locations; Videos, pictures or audios you have captured; other data transferred via Bluetooth, USB cable, etc.

Find Device

Find Device helps you to find your lost device, wipe lost device data remotely, and perform a host of other security functions.

4 Settings.....

To go to **Settings**, touch  from the Home screen.

You can also swipe down from the notification panel and touch .

4.1 Network & internet

Internet

Wifi

To turn Wi-Fi on and connect to a wireless network

- Touch **Settings > Network & internet > Internet > Wi-Fi**.
- Turn on .
- Once Wi-Fi is turned on, detected Wi-Fi networks are listed.
- Touch a Wi-Fi network to connect to it. If the network you selected is secured, you are required to enter a password or other credentials (you should contact the network operator for details). When finished, touch **Connect**.

To add a Wi-Fi network

When Wi-Fi is on, you can add new Wi-Fi networks according to your preference.

- Touch **Settings > Network & internet > Internet > Wi-Fi > Add network**.
- Enter the name of the network and any required network information.
- Touch **CONNECT**.

To forget a Wi-Fi network

The following steps prevent automatic connection to networks which you no longer wish to use.

- Turn on Wi-Fi, if it's not already on.
- On the Wi-Fi screen, touch the name of the saved network.
- Touch **FORGET** in the dialog that opens.

Network preference

- **WLAN+**

Automatically switch between Wi-Fi and mobile data to stay on line.

- **Turn on Wi-Fi automatically**

Wi-Fi will turn back on near-quality saved networks, like your home network.

- **Notify for public networks**

Notify when a high-quality public network is available.

Saved networks

Check the networks you saved.

Data usage

The first time you turn on your phone with your SIM card inserted, it will automatically configure your network service: 2G, 3G, or 4G.

By enabling Data saver, you can reduce data usage by preventing some apps from sending or receiving data in the background.

You can connect to the internet when your phone is within range of a wireless network. Wi-Fi can be used on your phone even without a SIM card inserted.

SIMs

Touch to choose SIM 1 or SIM 2 for connecting to the network, making calls and sending SMS messages.

Airplane mode

Turn on **Airplane mode**  to simultaneously disable all wireless connections including Wi-Fi, Bluetooth and more.

Hotspot & tethering

To share your phone's data connection via Wi-Fi, Bluetooth and USB, or as a mobile hotspot, go to **Settings > Network & internet > Hotspot & tethering** to activate these functions.

To rename or secure your mobile hotspot

When your mobile hotspot is activated, you can rename your phone's Wi-Fi network (SSID) and secure its Wi-Fi network.

- Touch **Settings > Network & internet > Hotspot & tethering > Wi-Fi hotspot**.
- Touch **Hotspot name** to rename the network SSID or set your network security.
- Touch **OK**.



The functions above may incur additional network charges from your network operator. Extra fees may also be charged in roaming areas.

Data saver

By enabling Data saver, you can reduce data usage by preventing some apps from sending or receiving data in the background.

VPN

Virtual private networks (VPNs) allow you to connect to the resources inside a secured local network from outside that network. VPNs are commonly deployed by corporations, schools, and other institutions so that their users can access local network resources when not inside that network, or when connected to a wireless network.

To add a VPN

- Touch **Settings > Network & internet > VPN** and then touch .
- On the screen that opens, follow your network administrator's instructions to configure each component of the VPN settings.
- Touch **SAVE**.

The VPN is added to the list on the VPN settings screen.

To connect to/disconnect from VPN

To connect to a VPN:

- Touch **Settings > Network & internet > VPN**.
- The VPNs you have added are listed. Touch the VPN you want to connect with.
- In the dialog that opens, enter any requested credentials and touch **CONNECT**.

To disconnect from a VPN:

- Touch the VPN you want to disconnect from. In the dialog that opens, touch **DISCONNECT**.

To edit/delete a VPN

To edit a VPN:

- Touch **Settings > Network & internet > VPN**.
- The VPNs you have added are listed. Touch the  icon next to the VPN you want to edit.
- After editing, touch **SAVE**.

To delete a VPN:

- Touch the  icon next to the selected VPN, then touch **FORGET** to delete it.

Private DNS

Touch to select private DNS mode.

4.2 Connected devices

USB

With a USB cable, you can charge your device, transfer files or photos (MTP/PTP) between your phone and a computer.

To connect your phone to the computer

- Use the USB cable that came with your phone to connect the phone to a USB port on your computer. You will receive a notification that the USB is connected.
- Open the Notification panel and choose the way which you want to transfer files or touch **Settings > Connected devices > USB** to select. By default, **No data transfer**.



Before using MTP, make sure that the driver (Windows Media Player 11 or higher version) has been installed.

+ Pair new device

Bluetooth is a short-range wireless communication technology that you can use to exchange data, or connect to other Bluetooth devices for various uses.

To turn on Bluetooth

- Touch **Settings > Connected devices > + Pair new device**.

Your device name will appear on screen.

To rename your device

- Touch **Settings > Connected devices > + Pair new device**.
- Touch **Device name**.
- Enter a name, and touch **RENAME** to confirm.

To pair/connect your phone with a Bluetooth device

To exchange data with another device, you need to turn Bluetooth on and pair your phone with the Bluetooth device with which you want to exchange data.

- Touch **Settings > Connected devices > + Pair new device**.
- Touch a Bluetooth device you want to pair your phone with in the list.
- In the dialog that pops up, touch **PAIR** to confirm.
- If the pairing is successful, your phone will be connected to the device.

To unpair from a Bluetooth device

- Touch the device you want to unpair from.
- Touch **FORGET** to confirm.

4.3 Apps

Touch to view details about the applications installed on your phone, to manage their data usage or force them to stop.

4.4 Notifications

In the Notifications menu, you can configure whether to block the notifications from this app, hide sensitive content, etc.

4.5 Battery

Tap any category in the battery management screen to view its power consumption.

4.6 Storage

Enter **Settings** > **Storage** to check the usage of storage space and free up more when necessary.

4.7 Scheduled power on/off

You can set the power on/off time under this function.

4.8 Sound & vibration

Use the Sound settings to configure many aspects of call ringtones, music, and other audio settings.

Do Not Disturb

If you do not want to be disturbed by your phone or information ringtones during work or rest, you can set the **Do Not Disturb** mode.

Default stream type

Set your Default stream type.

Phone ringtone

Phone ringtone provides options to select and personalize the sound that plays when you receive a phone call.

You can choose a pre-installed ringtone that came with your phone or use a custom ringtone that you have downloaded or saved on your phone.

Vibration & Haptics

This menu provides options to control vibration patterns, intensity, and haptic feedback for various system events and interactions.

More sound settings

Set dial pad tones, screen locking sounds, touch sounds, etc.

4.9 Display

In this menu, you can adjust your Dark theme, Display size and text, etc.

To rotate screen contents when device is rotated, touch Auto-rotate screen.

4.10 Wallpaper & Style

With this menu, set your home apps, choose your favorite wallpapers and theme styles, etc.

4.11 Accessibility

Use the **Accessibility** settings to configure any accessibility plug-ins you have installed on your phone.

4.12 Security & privacy

App security

Play Protect regularly checks your apps and device for harmful behaviour. You'll be notified of any security risks found.

Device unlock

Screen lock

Select one method such as **Swipe**, **Pattern**, **PIN** or **Password** to unlock the screen.

Face unlock

Face unlock allows you to unlock your device with your facial data. Set it according to the on-screen steps.

Ensure that you are facing the phone screen when using face recognition.

Fingerprint

Use your fingerprint to unlock the screen. Set it according to the on-screen steps.

NOTE: You need to set a pattern, PIN, or password before using face & fingerprint unlock.

Account security

Adding a Google account enhances the overall account security and provides additional layers of protection for your device.

Device finders

Device finders help you locate this device remotely. If you lose this device, it also helps you keep your data safe.

System and updates

Adding a Google account enhances the overall account security and provides additional layers of protection for your device.

Privacy

The **Privacy** menu offers essential features to protect your personal information and control privacy settings. Adjust app permissions to control data access, enable or disable location services for added privacy, and customize privacy settings according to your preferences. Regularly review and adjust settings in this menu to ensure your personal information is protected and enjoy a secure and private experience on your phone.

Other settings

More security and privacy settings are available under this menu.

4.13 Location

Touch to set whether to allow an app to access your device's location. You can set to allow continual access, or only while the app is in use.

4.14 Safety & emergency

To protect yourself in emergency, you can set emergency information such as medical information, emergency contacts in advance. You can also use SOS or turn on location and wireless emergency alerts.

4.15 Passwords & accounts

Passwords

You can save passwords to Google Password Manager and use these saved passwords on any device.

Accounts

Touch to add, remove, and manage your email and other supported accounts. You can also use these settings to control the options for how all applications send, receive and synchronize data; i.e. if this is done automatically, according to a schedule for each app, or not at all.

Touch **+Add account** to add an account for the selected app.

4.16 Passwords, passkeys & accounts

Choose preferred service to save data for sign-in and autofill suggestions. Turn on additional services if you'd like them to provide suggestions too.

4.17 Digital Wellbeing and parental controls

In this menu you can find how much time you have spent on the phone and even on each app. You can customize the time limit for using the phone to ensure a healthy and balanced life.

In addition, parents are able to restrict their children's usage time to manage their browsing habits.

4.18 Google

Touch to configure your Google account and service settings.

4.19 System

Languages

Select the language you want to use. If the language is not listed, touch Add a language, then locate and touch it to add it to the list.

Keyboard

Touch to configure your on-screen keyboard, improve accuracy with autocorrect features, and adjust pointer speed that suits your taste.

Gestures

To set some gestures for convenient use, such as 3-finger screenshot, Lift to wake.

Date & time

Use Date & time settings to customize your preferences for how date and time are displayed.

Memory extension

When the mobile phone has sufficient storage space, part of the storage space can be converted into expanded memory, which makes the system run more smoothly.

Backup

Turn on  to back up your phone's settings and other application data to Google servers. If you replace your phone, the settings and data you've backed up will be restored onto the new phone when you sign in with your Google account.

System Update

If you want to update the system, touch **CHECK FOR UPDATES**

Reset options

Touch to reset Mobile Network settings, bluetooth & Wi-Fi and app preferences, you won't lose your data with these settings.

If **Erase all data (factory reset)** is selected, all data in your phone's internal storage will be erased, please back up your data before reset.

Regulatory & safety

Touch to view product information such as **Product model**, **Manufacturer name/address**, **IMEI**, **CU reference**, **Bluetooth Declaration ID**, etc.

4.20 About phone

The menu provides essential information related to your phone's hardware, software, and system details. In this menu, you can access vital information such as device model, operating system version, and hardware specifications. Additionally, you may view legal information, privacy policy, etc.

5 Troubleshooting

Before contacting the service centre, here are some instructions to help you troubleshoot your device:

- For optimal operation, fully charge the battery.
- To improve the phone's performance, remove unnecessary files or apps on your phone.
- Update your phone's software via **Settings > System > System Update**.

My phone can't be switched on or is frozen

- When the phone can't be switched on, charge for at least 20 minutes to ensure the minimum battery power needed. Then switch it on again.
- When the phone falls into a loop during power on animation and the user interface can't be accessed, press and hold the **Power** key to reset. This eliminates any abnormal OS booting issues caused by third party applications.

My phone has not responded for several minutes

- If your phone doesn't respond, turn off your phone by pressing and holding the **Power** key until it turns off and then restart it again.
- If it still doesn't work, reset the phone.

My phone turns off by itself

- Check that your screen is locked when you are not using your phone, and make sure that the **Power** key is not accidentally pressed while the screen is unlocked.
- Check the battery charge level.
- If it still doesn't work, reset the phone or update software.
- If the issue occurs while using a certain third-party app, make sure the app is compatible with your device and Android version. Try uninstalling the third-party app.

My phone can't charge properly

- Make sure that you are using the Alcatel charger that comes with the phone.

- Make sure that your battery is not completely discharged; if the battery power has been empty for a long time, it may take around 20 minutes to display the battery charging indicator on the screen.
- Make sure that charging is carried out under normal conditions 0°C (32°F) to 45°C (113°F).
- When abroad, check that the voltage input is compatible.

My phone can't connect to a network or "No service" is displayed

- Try connecting to the network by moving to another physical location.
- Verify the network coverage with your operator.
- Check with your operator that your SIM card is valid.
- Try connecting at a later time if the network is overloaded.
- Try to turn on "Aeroplane mode" for a few seconds, then turn Aeroplane mode off.

My phone can't connect to the internet

- Make sure that the internet access service of your SIM card is available.
- Check your phone's internet connection settings.
- Make sure that you are in a place with network coverage.
- Try connecting at a later time or another location.
- Try to turn on "Aeroplane mode" for a few seconds, then turn Aeroplane mode off.

Invalid SIM card

- Make sure that the SIM card has been correctly inserted.
- Make sure that the chip on your SIM card is not damaged.
- Make sure that the service of your SIM card is available.

My phone can't make outgoing calls

- Make sure that you have dialled a valid number and have touched .
- For international calls, check the country and area codes.

- Make sure that your phone is connected to a network, and the network is not overloaded or unavailable.
- Check your subscription status with your operator (credit, SIM card valid, etc.).
- Make sure that you have not barred outgoing calls.
- Make sure that your phone is not in Aeroplane mode.

My phone can't receive incoming calls

- Make sure that your phone is switched on and connected to a network (check for overloaded or unavailable network).
- Check your subscription status with your operator (credit, SIM card valid, etc.).
- Make sure that you have not forwarded incoming calls.
- Make sure that you have not barred certain calls.
- Make sure that your phone is not in Aeroplane mode.

The caller's name/number doesn't appear when a call is received

- Check that you have subscribed to this service with your operator.
- Your caller may have concealed his name or number.

I can't find my contacts

- Make sure that your SIM card is not broken.
- Make sure that your SIM card is inserted properly.

The sound quality of the calls is poor

- Adjust the volume during a call by pressing the **Volume** key.
- Check the network strength. Move to a location with stronger signal strength.
- Make sure that the receiver, connector and speaker on your phone are clean.

I can't use the features described in the manual

- Check with your operator to make sure that your subscription includes this service.
- Make sure that this feature doesn't require a Alcatel accessory.

When I select a number from my contacts, the number can't be dialled

- Make sure that you have correctly recorded the number in your contacts.
- Make sure that you have selected the country code when calling an international number.

I can't add a contact

- Make sure that your SIM card contacts are not full; delete some contacts or save the contacts to the phone.

My callers can't leave messages on my voicemail

- Contact your network operator to check service availability.

I can't access my voicemail

- Make sure that your operator's voicemail number is correctly entered in "Voicemail number".
- Try later if the network is busy.

I can't send and receive MMS

- Check your phone storage as it might be full.
- Contact your network operator to check service availability and MMS parameters.
- Verify the server centre number or your MMS profile with your operator.
- The server centre may be swamped. Try again later.

SIM card PIN locked

- Contact your network operator to obtain the PUK (Personal Unblocking Key) code.

I can't connect my phone to my computer

- Check to make sure the USB port is not broken. If it's not working, try another USB port on your computer.
- Make sure USB drivers are properly installed.
- If you are using a Windows computer, make sure it supports MTP mode. If you are using a Mac, make sure to install Android File Transfer from www.android.com/filetransfer/.

I can't download new files

- Make sure that there is sufficient phone storage space for your download.
- Select the microSD card as the location to store downloaded files.
- Check your subscription status with your operator.

The phone can't be detected by others via Bluetooth

- Make sure that Bluetooth is turned on and your phone is visible to other users.
- Make sure that the two phones are within Bluetooth's detection range.

The battery drains too fast

- Make sure that you follow the complete charge time (minimum 120 minutes).
- After a partial charge, the battery level indicator may not be exact. Wait for at least 20 minutes after removing the charger to obtain an exact indication.
- Adjust the brightness of screen as appropriate.
- Extend the email auto-check interval for as long as possible.
- Update news and weather information on manual demand, or increase their auto-check interval.
- Exit background-running applications if they are not being used for extended periods of time.
- Turn off Bluetooth, Wi-Fi, or GPS when not in use.

The phone becomes warm following prolonged calls, game playing, internet surfing or running other complex applications

- This heating is a normal consequence of the CPU handling excessive data. Ending the above actions will make your phone return to normal temperature.

After a factory data reset is performed, I can't use my phone without entering Google account credentials

- After a reset is performed, you must enter the original Google account credentials that were used on this phone.
- If you don't remember your Google account credentials, complete Google account recovery procedures.
- If you still cannot access your phone, apply to the authorized repair centre, but remember that it will not be regarded as a warranty case.

I forgot some passwords/codes/keys on my phone

- Perform a factory data reset.
- If you still cannot access your phone, apply to the authorized repair centre, but remember that it will not be regarded as a warranty case.

No action after touching the touch screen

- Check whether there is any damage to the screen. If yes, please back up your data and take your device and proof of purchase to our repair centre to get more professional technical assistance.
- If the issue occurs while using a third-party app, make sure the app is compatible with your device and Android version. Try uninstalling the third-party app.
- Check if the issue occurs during charging. If yes, we recommend trying the official charger and data cable.

(Note: The voltage instability of non-standard chargers and data cables may cause the touchscreen to become unresponsive).

- Make sure the temperature where the device is being used is neither too hot nor too cold. The standard working temperature of the capacitive touchscreen is -10°C~60°C. Excessively high or low temperatures will cause the touchscreen to become unresponsive.
- If there is a screen protector on the screen, see if the touchscreen works after removing it.
- Make sure there are no stains such as water or sweat on the touchscreen. If there are, wipe the screen and try again.
- If it still doesn't work, reset the phone or update software.

Cannot turn on camera flash mode

- Charge your device until the battery level is at least 30%. Camera flash cannot be used when the battery is running low.
- Clear the cache of the **Camera** app.

To clear an app's cache: go to the main menu, select **Settings > Apps > See all apps > Camera > Storage & cache**, select **Clear storage** and **Clear cache**.

- Drag down the quick settings bar in any interface, touch the flashlight icon to check whether the flash on your device works.
- Check whether the camera is set to the special shooting mode. In order to achieve a certain effect, the program will prohibit the use of the flash. Please revert to normal camera shooting mode.

How to back up my device data

- Go to **Settings > System > Backup** (refer to "4.19 System > Backup")

6 Specifications

Platform:

- UNISOC SC9863A1

OS:

- Android 15 Go

Memory ⁽¹⁾ :

- (3GB RAM Expansion)+64GB ROM

Dimensions (LxWxT):

- 164.44 x 75.78 x 8.75mm

Weight:

- 185.5g

Display:

- 6.517" HD+, 720*1612; 60Hz

Network:

- 2G: 850/900/1800/1900
- 3G: B1/2/4/5/8
- 4G: B1/B2/B3/B4/B5/B7/B8/B12/B13/B17/B20/B26/B28/B66/B38/B40/B41

Connectivity:

- Bluetooth 4.2
- 802.11 b/g/n
- 3.5 mm audio jack
- Type-C 2.0

⁽¹⁾ Depending on the device you purchased.

Camera:

- Rear camera: 13M FF
- Front camera: 5M FF

Audio & Video supported formats:

- AAC, HE-AAC v1, HE-AAC v2, AMR, AWB, MIDI, MP3, OGG VORBIS, WAV(Alaw/Ulaw), WAV(Raw), FLAC, OPUS
- MPEG2, H.263, MPEG4, H.264, H.265, VP8, VP9

Battery ⁽¹⁾:

- Capacity: 5010 mAh

Expansion Slot:

- MicroSD™ memory card

(Availability of MicroSD card up to 1TB)

Sensors:

- G-sensor

Note: Specifications are subject to change without prior notice.

⁽¹⁾ The original battery has undergone rigorous safety inspections to meet qualification standards, the use of non-original batteries may be dangerous.

7 Accessories

Standard accessories

- Charger ⁽¹⁾
- Type C Cable
- LCD sticker
- Quick guide
- SIM card pin



- Accessories depend on countries.
- Only use the accessories included along with your device.

8 Licences



Bluetooth SIG, Inc. licensed and certificated Alcatel A31 Prime T451A1
Bluetooth Design Number Q304553



Wi-Fi Alliance certificated

9 Disclaimer

There may be certain differences between the user manual description and the phone's operation, depending on the software release of your phone or specific carrier services.

TCL Communication Ltd. shall not be held legally responsible for such differences, if any, nor for their potential consequences, which responsibility shall be borne by the carrier exclusively.

⁽¹⁾ If sold with the device, depending on the device you purchased.